

GRETTO TR

Installation Manual



GRETTO



GRETTO WASH



GRETTO DIFFUSED

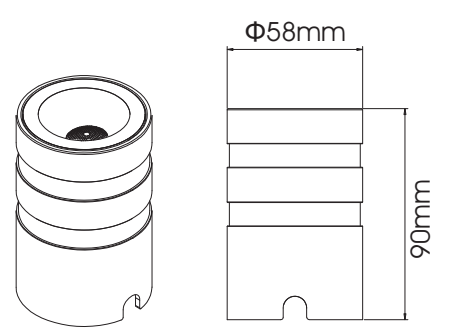

1



Attention

Before any maintenance switch off the main power.

- 2.1 Open the luminaire hole.
- 2.2 Open a hole near the luminaire hole for the IP68 Junction Box.
- 2.3 Then connect the 2 holes with a pipe.

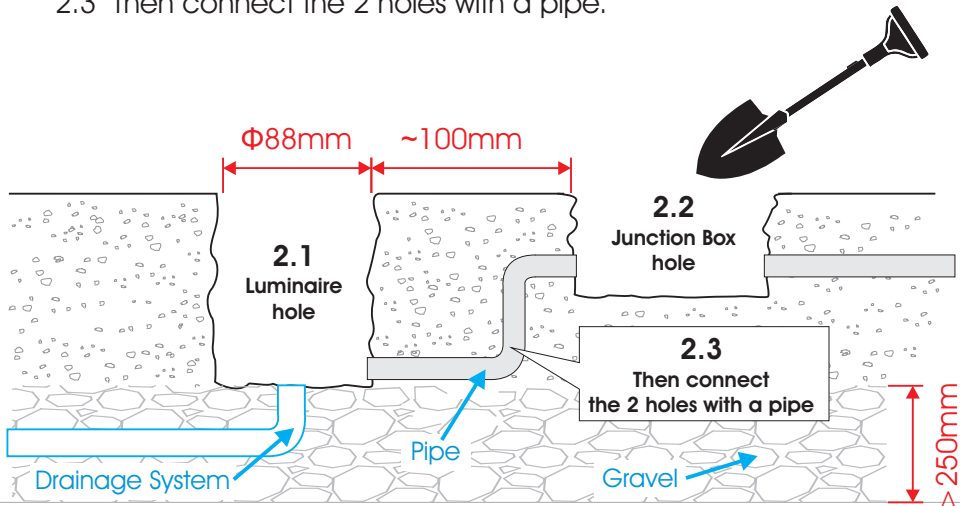

3 Place the housing box.

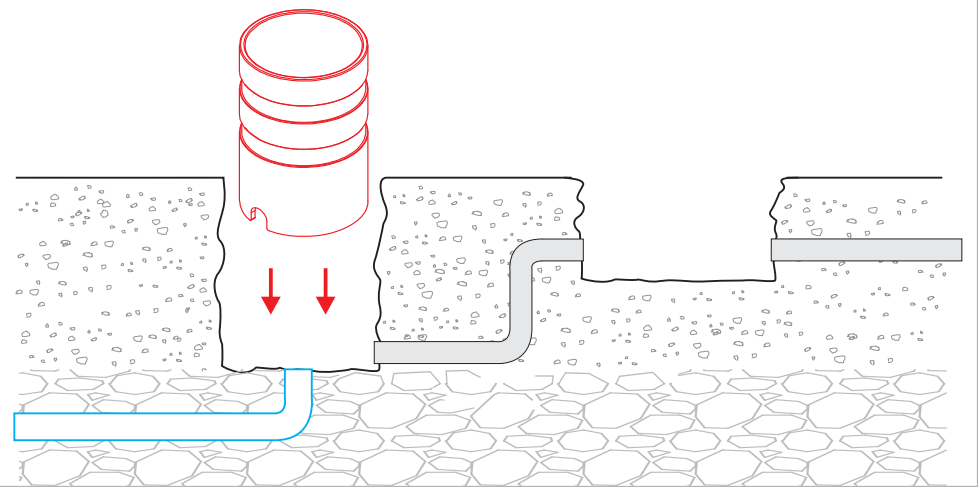

4 Fill the luminaire hole with concrete. Then wait until it gets dry.

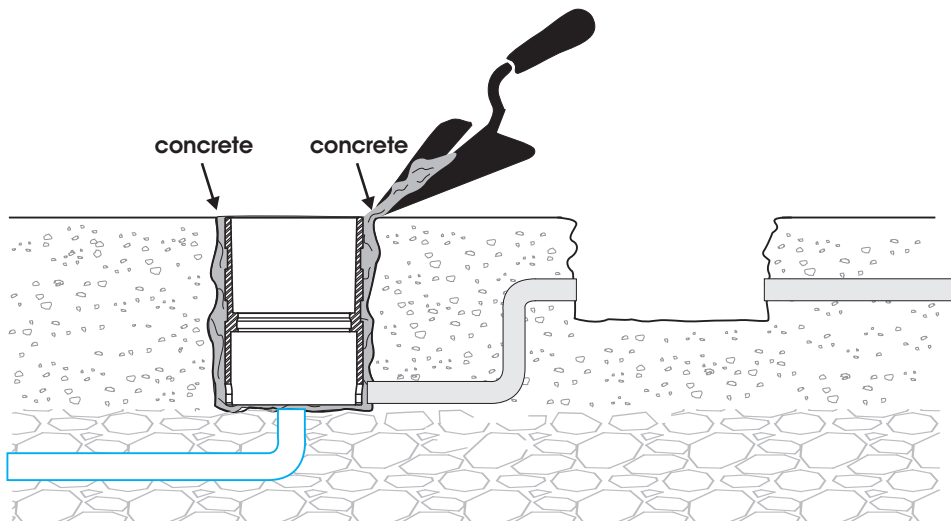

5 Pass the cable of GRETTO TR from the housing box to the Junction Box and make the connections.

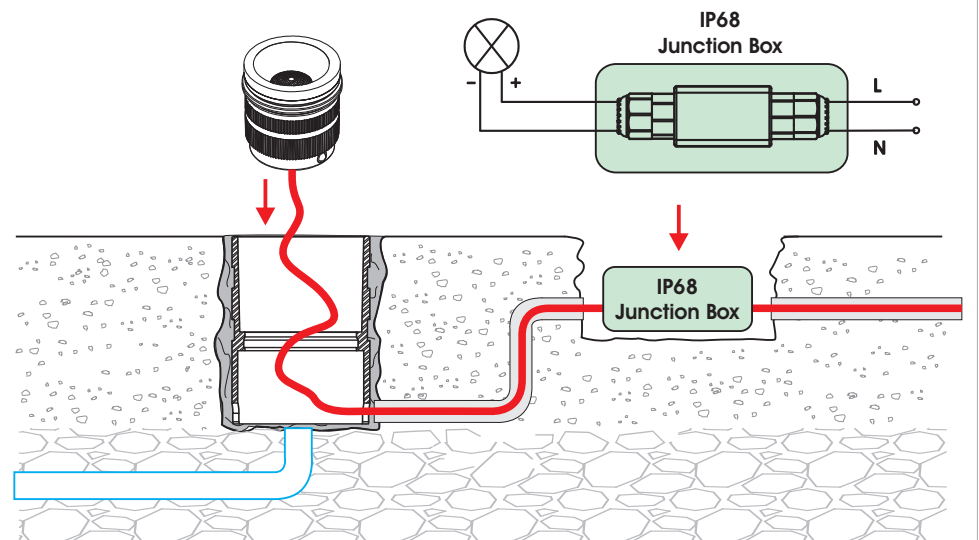

6 Place a material of your desire to close the Junction Box hole.

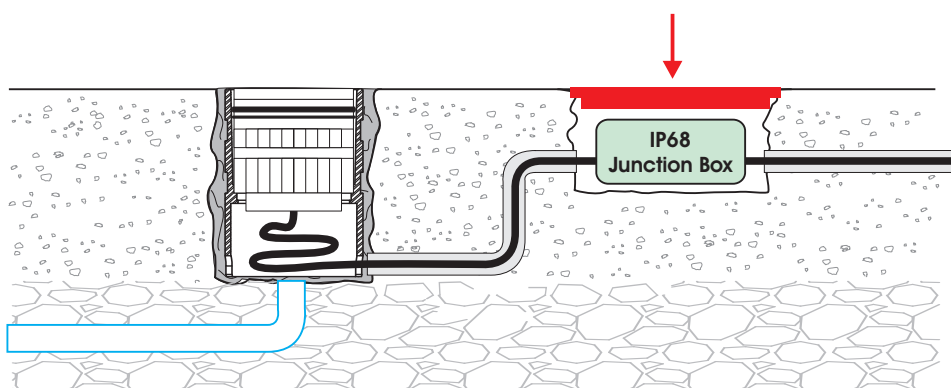

7

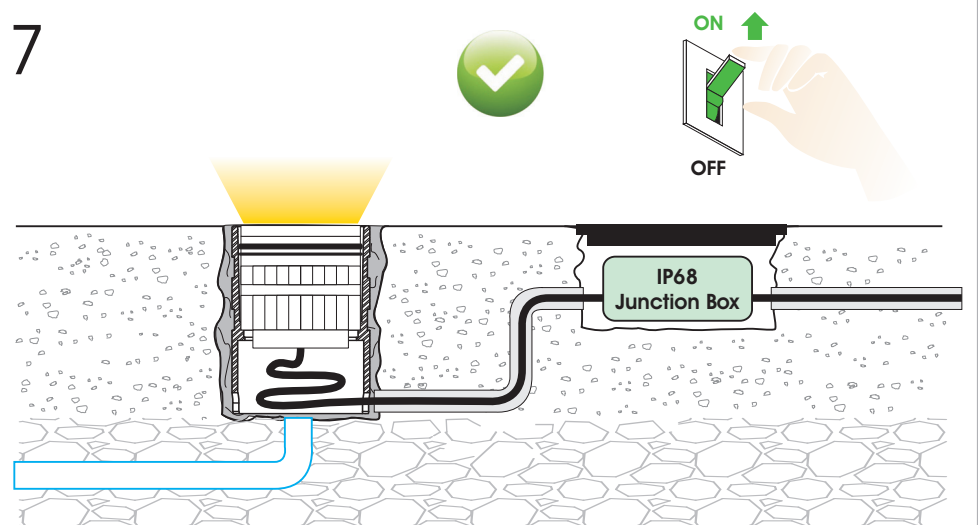

Attention

