

LOOP PDD/PDDI

(Pendant Direct/Pendant Direct-Indirect)

- LOOP is a complete series of square with rounded corner luminaires available for surface, pendant, recessed and trimless application.
- The pendant version is offered either with only Direct or Direct/Indirect illumination.
- It consists of two models: High Power and High Efficiency.
- It is offered with a Low Glare (UGR < 21,8*) as an option in the High Power model.
- It is offered with a Low UGR (UGR < 18,6*) as an option in the High Efficiency model.
- Luminaire material: Aluminium.
- Cover material: PMMA
- Powder Coated: Black (RAL9005), White (RAL9003), or Grey (RAL7037) as standard.
- Custom luminaire colours also available on request.
- Low tolerances for colour temperature (MacAdam 3).
- Lumen maintenance L80/B10 50.000h
- Emergency Function capability. (3 hours, with build-in rechargeable battery).
- Indoor Use: IP40

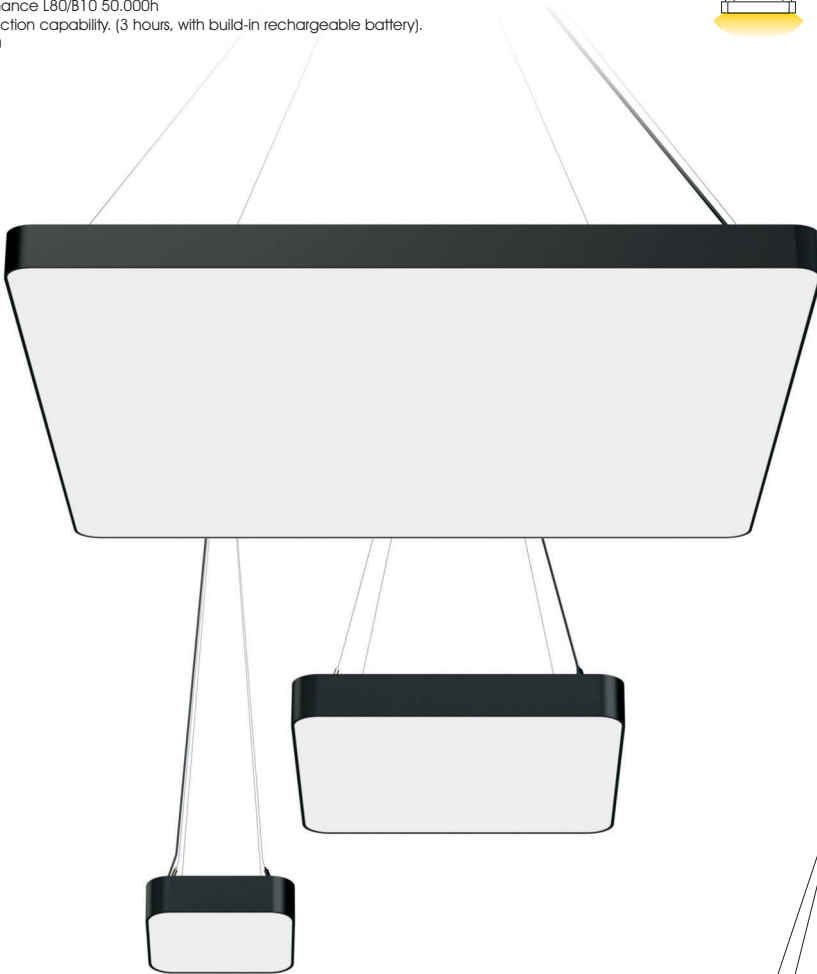
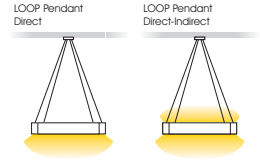

LED source efficacy up to 203lm/W (4000K)

Luminaire efficacy up to 138lm/W (4000K)

Available upon request:

- ✓ Custom luminaire colours
- ✓ Emergency version

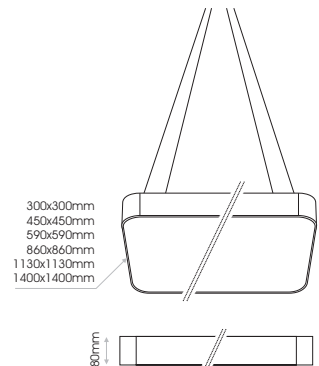

*Glare Evaluation: X=4H / Y=8H, S=0,25H, Reflection factors: 70/50/20



Pendant Direct

Model	Luminaire Colour*	CCT	Watt / Diameter	CRI** LED Source	CRI** LED Source	Type	Voltage	Dimming Option	Extras	
LOOP Pendant Direct High Power <i>(LOOP PDD HP)</i>	White <i>(WH)</i>	3000K <i>(30)</i>	HIGH POWER	≥ 80 <i>(80)</i>	≥ 80 <i>(80)</i>	Opal <i>(OP)</i>	230VAC <i>(230)</i>	Non Dimmable <i>(ND)</i>	Function Standard <i>(0XX)</i> Emergency <i>(1XX)</i>	
	Black <i>(BL)</i>	4000K <i>(40)</i>	17.6W / 30x30cm <i>(18W3030)</i>	2660lm	2780lm	Low Glare <i>(LG) ***</i>	Analogue <i>(1-10V) (A1)</i>			
	Grey <i>(GR)</i>	4000K <i>(40)</i>	39.5W / 45x45cm <i>(40W4545)</i>	5860lm	6160lm	Opal <i>(OP)</i>	230VAC <i>(230)</i>	DALI <i>(DL)</i>	Canopy - Wire Rope Length No Canopy - 1.5m <i>(X00)</i> 3m <i>(X01)</i> Cable SF - 1.5m <i>(X10)</i> 3m <i>(X11)</i> Cable RC - 1.5m <i>(X20)</i> 3m <i>(X21)</i> Cable TR - 1.5m <i>(X30)</i> 3m <i>(X31)</i> Hybrid SF - 1.5m <i>(X40)</i> 3m <i>(X41)</i> Hybrid RC - 1.5m <i>(X50)</i> 3m <i>(X51)</i> Hybrid TR - 1.5m <i>(X60)</i> 3m <i>(X61)</i> Metal tube****1.2m <i>(X70)</i> (without wire ropes)	
			75W / 59x59cm <i>(75W5959)</i>	10720lm	11270lm					
			153.5W / 86x86cm <i>(154W8686)</i>	22150lm	23290lm					
			272.8W / 113x113cm <i>(273W113113)</i>	39380lm	41400lm					
			426.3W / 140x140cm <i>(426W140140)</i>	61540lm	64700lm					
			6.6W / 30x30cm <i>(07W3030)</i>	1130lm	1180lm					Low UGR <i>(LU) ****</i>
			13.4W / 45x45cm <i>(13W4545)</i>	2250lm	2370lm					
			25.9W / 59x59cm <i>(26W5959)</i>	4200lm	4410lm					
58.3W / 86x86cm <i>(58W8686)</i>	9450lm	9930lm								
103.7W / 113x113cm <i>(104W113113)</i>	16790lm	17650lm								
162W / 140x140cm <i>(162W140140)</i>	26230lm	27580lm								

* Custom luminaire colours available upon request.
** Available in CRI90 upon request.
*** Low Glare (UGR<21,8), Low UGR (UGR<18,6)
**** Metal tube is not available for 27cm.

Ordering Code Example: LOOP PDD HP-BL-30-154W8686-80-LG-230-ND-011

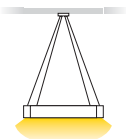

Pendant Direct-Indirect

Model	Luminaire Colour*	CCT DIRECT- INDIRECT	Watt / Diameter	CRI** LED Source	CRI** LED Source	Type	Voltage	Dimming Option	Extras		
LOOP Pendant Direct-Indirect High Power <i>(LOOP PDDI HP)</i>	White <i>(WH)</i>	3000K 3000K <i>(3030)</i>	HIGH POWER	≥ 80 <i>(80)</i> 3000K	≥ 80 <i>(80)</i> 4000K	Opal <i>(OP)</i>	230VAC <i>(230)</i>	Non Dimmable <i>(ND)</i>	Function Standard <i>(0XX)</i> Emergency <i>(1XX)</i>		
	Black <i>(BL)</i>	3000K		DIRECT- INDIRECT	DIRECT- INDIRECT	Low Glare <i>(LG)***</i>		Analogue <i>(1-10V) (A1)</i>		Canopy - Wire Rope Length No Canopy - 1.5m <i>(X00)</i> Emergency <i>(1XX)</i>	
	Grey <i>(GR)</i>	4000K 4000K <i>(3040)</i>		26W / 30x30cm <i>(26W3030)</i>	2660lm 1400lm	2780lm 1440lm		DALI <i>(DL)</i>			Canopy - Wire Rope Length 3m <i>(X01)</i> Cable SF - 1.5m <i>(X10)</i> 3m <i>(X11)</i> Cable RC - 1.5m <i>(X20)</i> 3m <i>(X21)</i> Cable TR - 1.5m <i>(X30)</i> 3m <i>(X31)</i> Hybrid SF - 1.5m <i>(X40)</i> 3m <i>(X41)</i> Hybrid RC - 1.5m <i>(X50)</i> 3m <i>(X51)</i> Hybrid TR - 1.5m <i>(X60)</i> 3m <i>(X61)</i>
		4000K 4000K <i>(4040)</i>		59.7W / 45x45cm <i>(60W4545)</i>	5860lm 2990lm	6160lm 3120lm		Wireless <i>(WL)</i>			
		4000K 3000K <i>(4030)</i>		114.5W / 59x59cm <i>(115W5959)</i>	10720lm 5860lm	11270lm 6160lm					
				235.3W / 86x86cm <i>(235W8686)</i>	22150lm 11570lm	23290lm 12160lm					
				409.4W / 113x113cm <i>(409W113113)</i>	39380lm 20900lm	41400lm 21820lm					
				641.1W / 140x140cm <i>(641W140140)</i>	61540lm 29720lm	64700lm 31230m					
LOOP Pendant Direct-Indirect High Efficiency <i>(LOOP PDDI HE)</i>			HIGH EFFICIENCY	≥ 80 <i>(80)</i> 3000K	≥ 80 <i>(80)</i> 4000K	Opal <i>(OP)</i>					
				DIRECT- INDIRECT	DIRECT- INDIRECT	Low UGR <i>(LU)***</i>					
				9.4W / 30x30cm <i>(09W3030)</i>	1130lm 550lm	1180lm 560lm					
				20.6W / 45x45cm <i>(21W4545)</i>	2250lm 1220lm	2370lm 1280lm					
				39.3W / 59x59cm <i>(39W5959)</i>	4200lm 2250lm	4410lm 2370lm					
				87.5W / 86x86cm <i>(88W8686)</i>	9450lm 4690lm	9930lm 4930lm					
				152.3W / 113x113cm <i>(152W113113)</i>	16790lm 8390lm	17650lm 8760lm					
				242.2W / 140x140cm <i>(242W140140)</i>	26230lm 12770lm	27580lm 13420lm					

- * Custom luminaire colours available upon request.
- ** Available in CRI90 upon request.
- *** Low Glare (UGR<21,8), Low UGR (UGR<18,6)



Ordering Code Example: LOOP PDDI HE-BL-30-88W8686-80-LU-230-ND-011



LOOP PDD

HIGH POWER
HIGH EFFICIENCY

18W	40W	75W	154W	273W	426W
7W	13W	26W	58W	104W	162W

LOOP PDDI

HIGH POWER
HIGH EFFICIENCY

26W	60W	115W	235W	409W	641W
9W	21W	39W	88W	152W	242W

Weight	1.55Kgs	3.46Kgs	6.24Kgs	11.70Kgs	18.80Kgs	28Kgs
---------------	---------	---------	---------	----------	----------	-------

Direct

HIGH POWER

Opal LOR 0.74

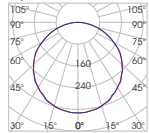

Low Glare LOR 0.73

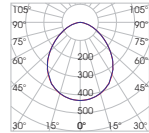

HIGH EFFICIENCY

Opal LOR 0.74

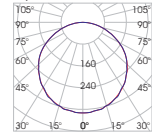

Low UGR LOR 0.73

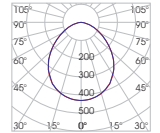

Indirect

HIGH POWER

Opal LOR 0.78

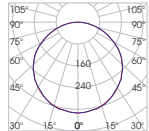

Low Glare LOR 0.78

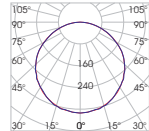

HIGH EFFICIENCY

Opal LOR 0.78

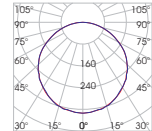

Low UGR LOR 0.78

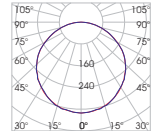

Canopies & Suspension

1. Cable SF (Surface)

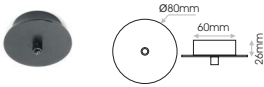

2. Cable RC (Recessed)

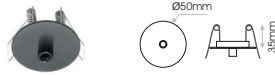

3. Cable TR (Trimless)

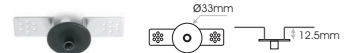

4. Hybrid SF (Surface)

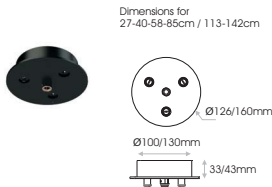

5. Hybrid RC (Recessed)

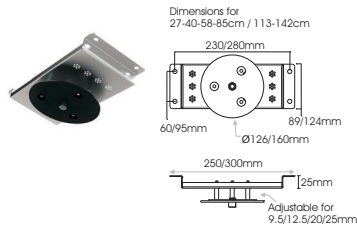

6. Hybrid TR (Trimless)

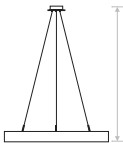
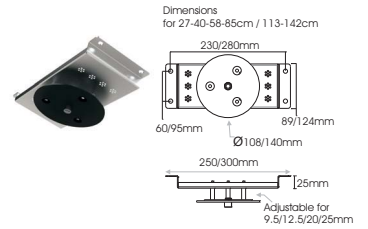

Minimum allowed ceiling-luminaire distances for Hybrid canopies

for 27cm - 35cm for 85cm - 85cm
for 40cm - 40cm for 113cm - 110cm
for 58cm - 60cm for 142cm - 160cm

For smaller distances, mount the wire ropes directly to the ceiling and use cable canopies.

7. Metal Tube Suspension (only for Pendant Direct models)

