

# MORETTO Retrofit Round

## Installation Manual

### Attention

Before any maintenance switch off the main power.

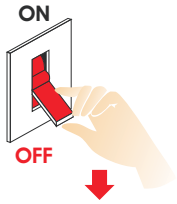

x1 x2 x2

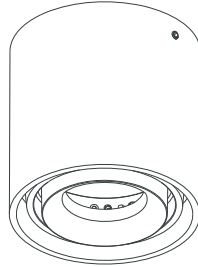

1

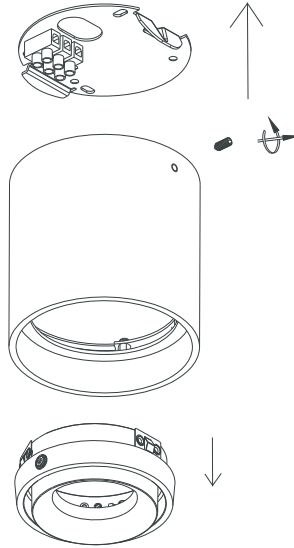

2

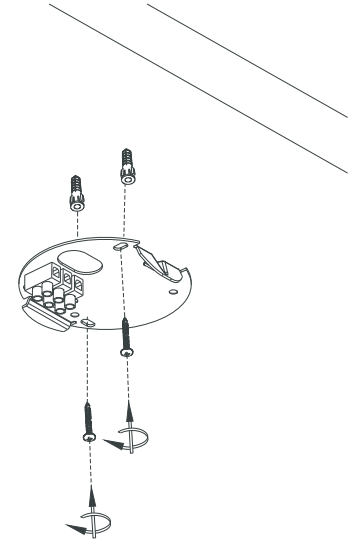

3

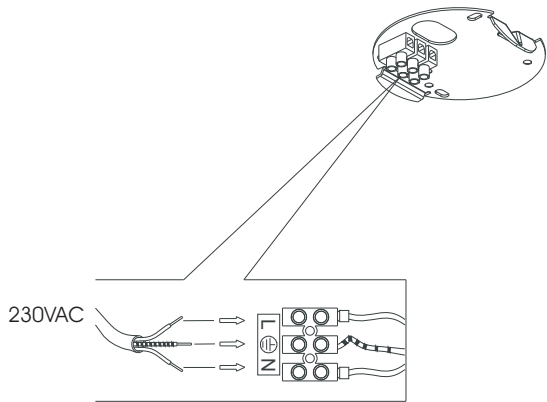

4

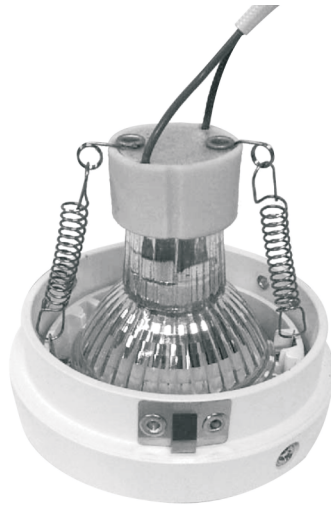

5

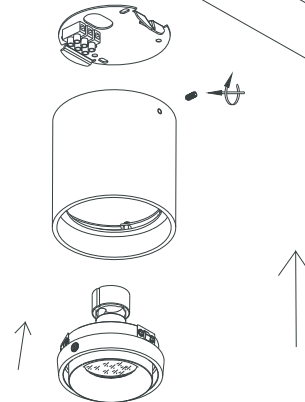

Make sure that the body of the luminaire is locked properly with the base before tightening the screw

6

