

MORETTO Retrofit Square

Installation Manual

Attention
Before any maintenance
switch off the main power.

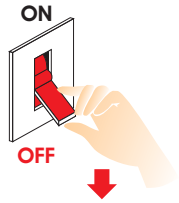

x1 x2 x2

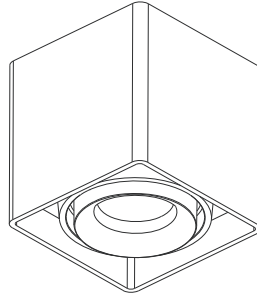

1

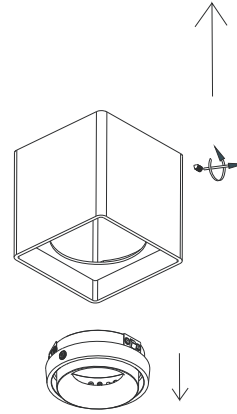

2

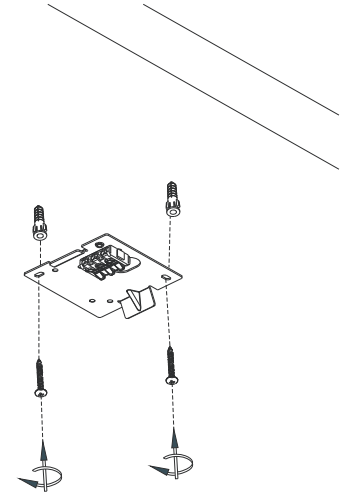

3

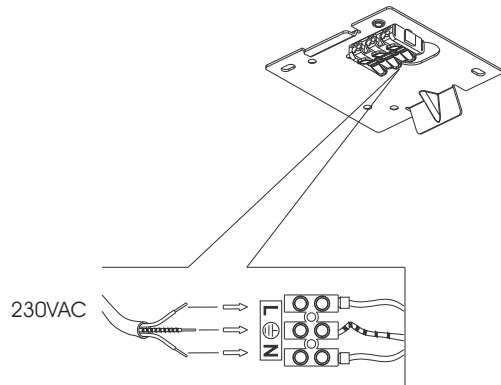

4

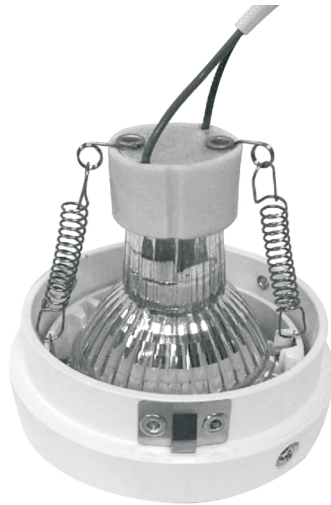

5

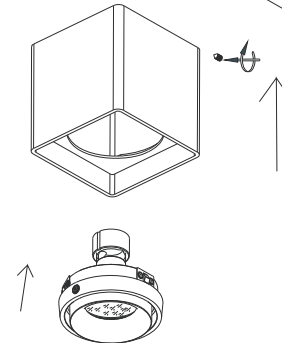

Make sure that the body of the luminaire
is locked properly with the base
before tightening the screw

6

