

OUTLINER 20 / OUTLINER 40

RECESSED Seamless

IP40 / IP66

Installation Guide

OUTLINER 20 Recessed Seamless

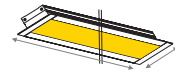
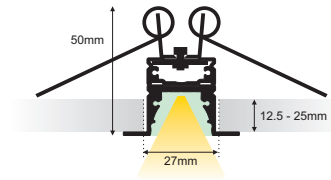
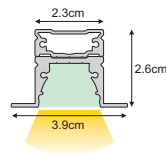

Dimensions:

for Monochromatic, Tunable White:
39x52.3/88.7/102.3/119/152.3/202.3cm
Cutting Hole:
27x51.3/87.7/101.3/118/151.3/201.3cm

for RGBWW-RGBCW 84LED/m:
39x52.3/88.7/102.3/123.7/152.3/202.3cm
Cutting Hole:
27x51.3/87/101.3/122.7/151.3/201.3cm

for RGBWW-RGBCW 60LED/m, RGB 60LED/m, RGB 30LED/m:
39x52.3/82.3/102.3/122.3/152.3/202.3cm
Cutting Hole:
27x51.3/81.3/101.3/121.3/151.3/201.3cm

for RGB 96LED/m:
39x52.3/89.8/102.3/121/152.3/202.3cm
Cutting Hole:
27x51.3/88.8/101.3/120/151.3/201.3cm



Note:

Cutting hole must be 10mm shorter than the luminaire length.

OUTLINER 40 Recessed Seamless

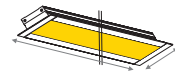
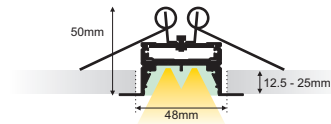
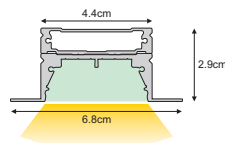

Dimensions:

for Monochromatic, Tunable White:
68 x 53.3/86.7/103.3/120/153.3/203.3cm
Cutting hole:
48 x 51.3/84.7/101.3/118/151.3/201.3cm

for RGBWW-RGBCW 84LED/m:
68 x 53.3/89/103.3/124.7/153.3/203.3cm
Cutting hole:
48 x 51.3/87/101.3/122.7/151.3/201.3cm

for RGBWW-RGBCW 60LED/m, RGB 60LED/m, RGB 30LED/m:
68 x 53.3/83.3/103.3/123.3/153.3/203.3cm
Cutting hole:
48 x 51.3/81.3/101.3/121.3/151.3/201.3cm

for RGB 96LED/m:
68 x 53.3/90.8/103.3/122/153.3/203.3cm
Cutting hole:
48 x 51.3/88.8/101.3/120/151.3/201.3cm



Note:

Cutting hole must be 20mm shorter than the luminaire length.

1

Attention
 Before any maintenance switch off the main power.

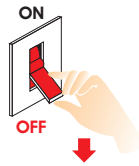

2

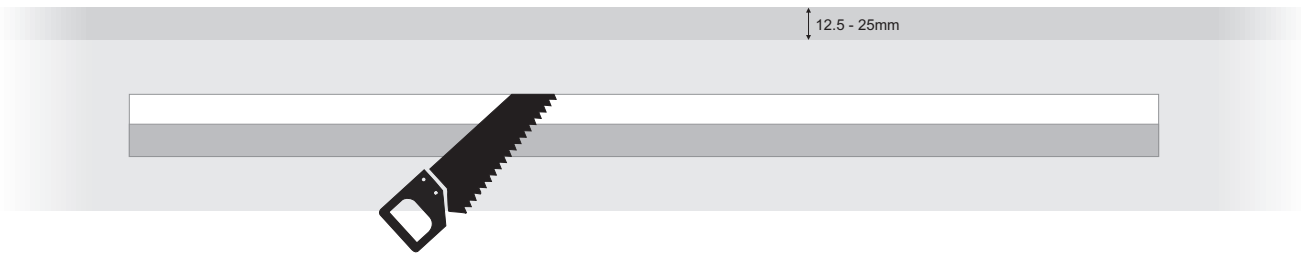

3

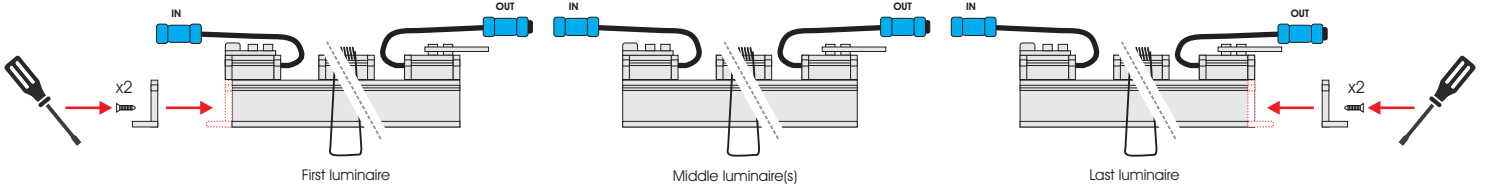

4

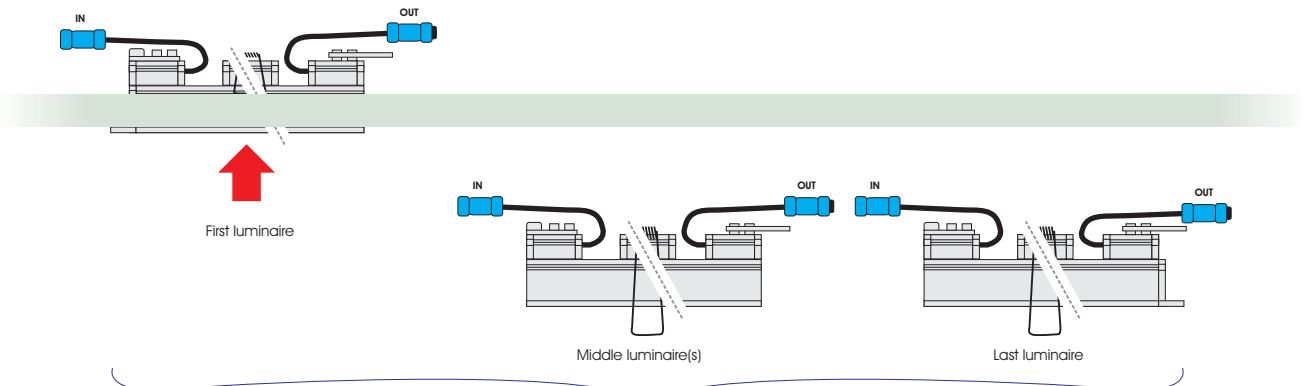

Maximum line power:
 Monochromatic and Tunable White 280Watt
 RGB and RGBW 160Watt

4.1

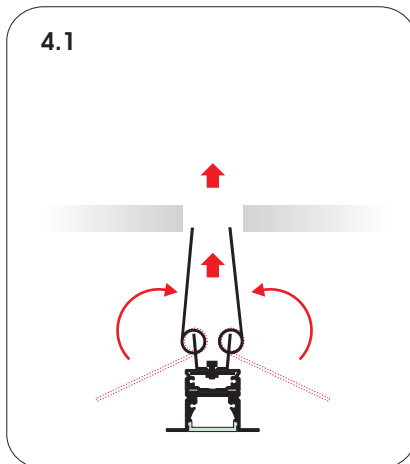

4.2

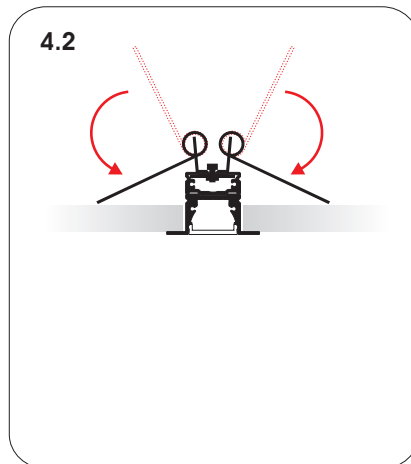

5

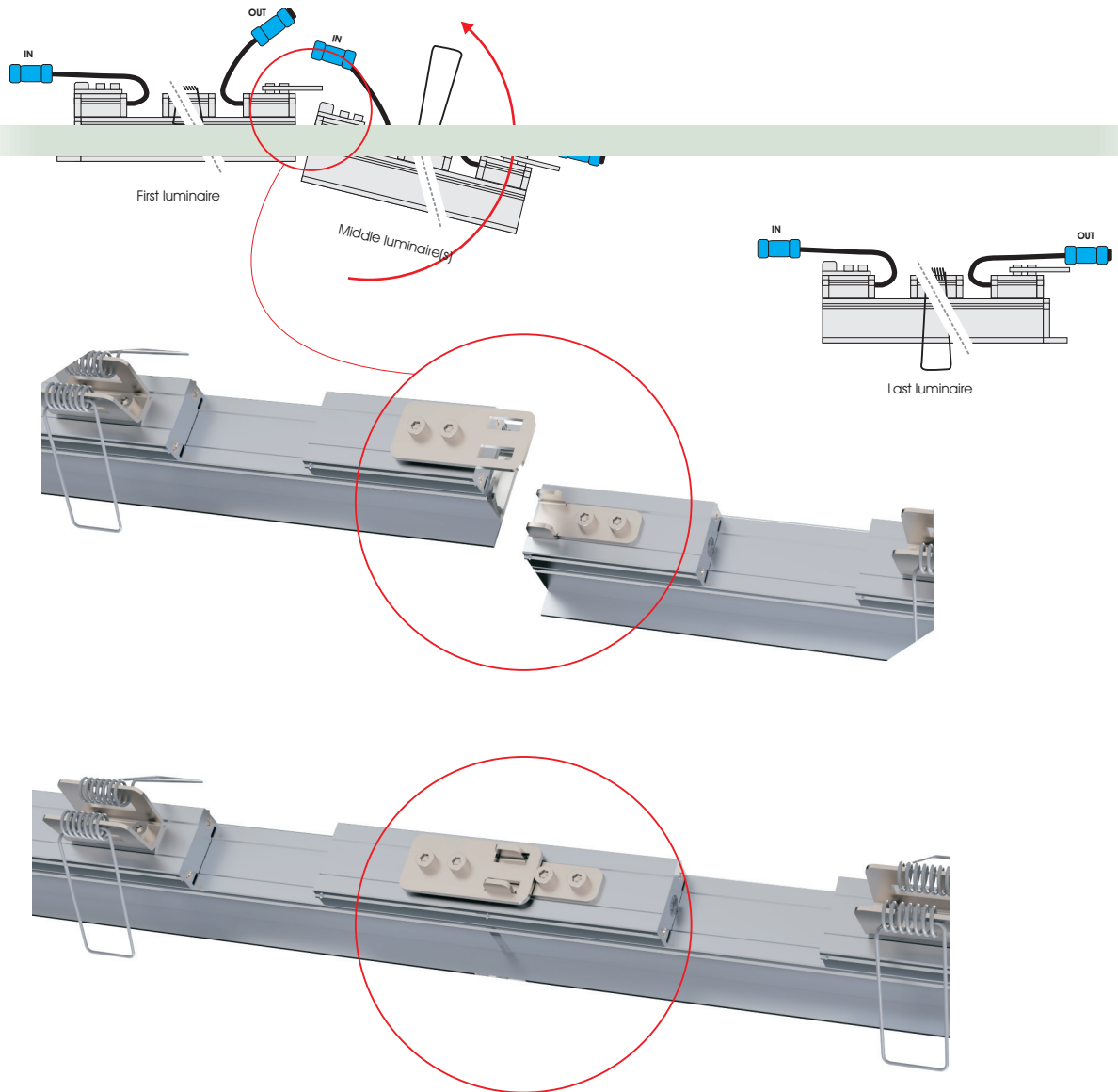

6

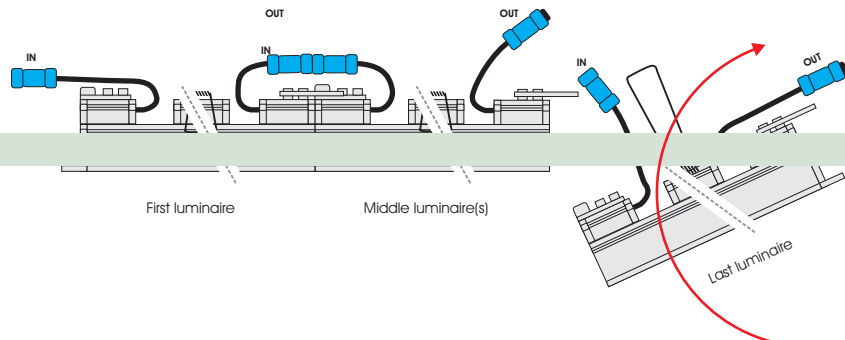

7

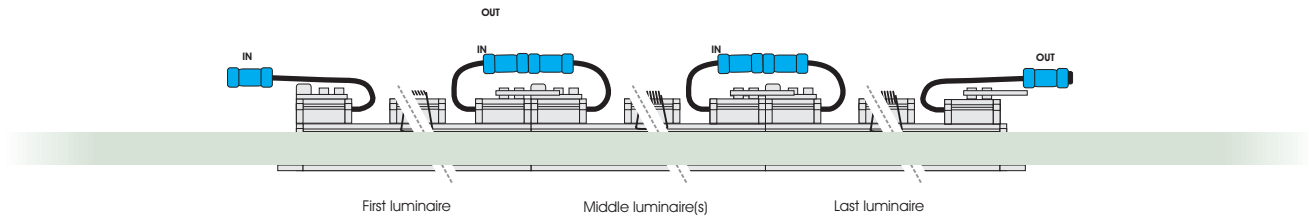

8

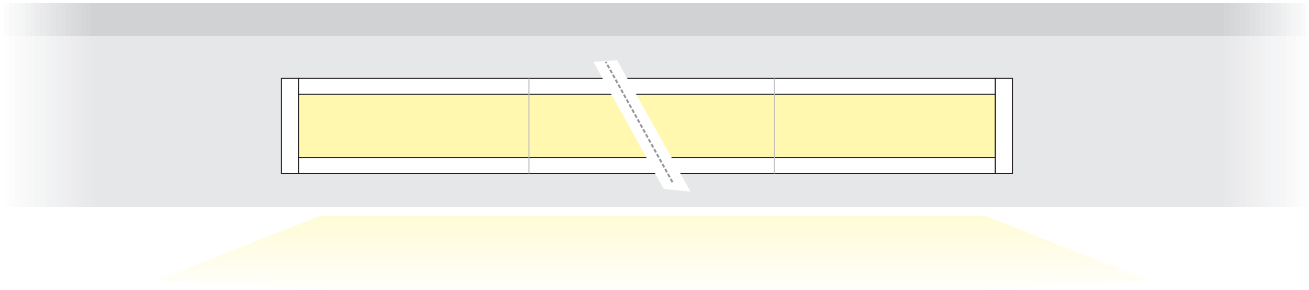
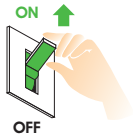

Distance (gap) between OUTLINER

OUTLINER Seamless does not require any gap between luminaires for total length up to 10m.

The distance (D) must be 0.75mm / 1m of seamless luminaire array.

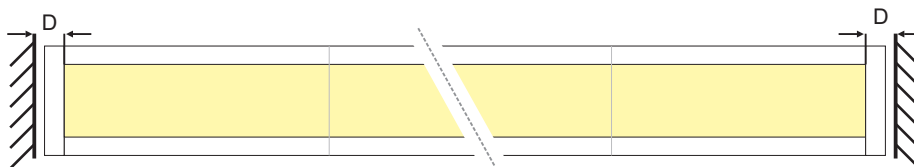

For total length above 10m, refer to "Distance (gap) between OUTLINER" paragraph.

IP Connectors Preparation Guide

Waterproof

Assembling and soldering process for the power plugs.

For assembling and soldering the 2 poles power plugs to the proper cable (same for 3p 4p and 5p cable), the following procedure must be followed in order to be ensured the correct soldering of the cables and the impermeability of the plugs to water.



Attention

This procedure is very important. Thus, if is not completed correctly, there is chance of water leakage through the plugs inside luminaire.

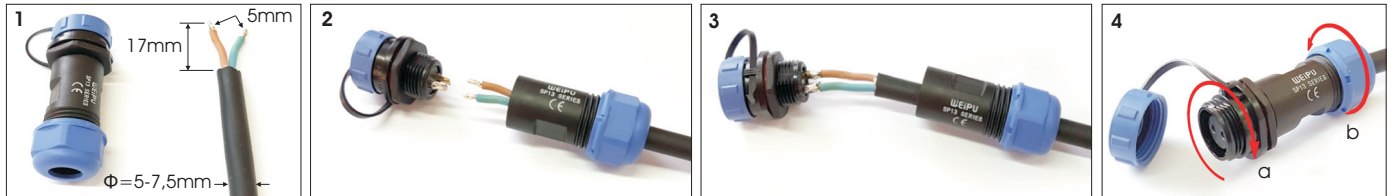

Picture 1. The cable that will be used need to have outer diameter 5-7,5mm. Remove the outer cable insulation by 17mm (maximum) and then remove the two inner insulations from the cables by exact 5mm.

Picture 2. Unscrew the front side from the plug. Insert the cable to the main body of the plug from cable gland's side. Galvanize cable's copper and terminals inside the plug.

Picture 3. Solder the cables to the plug's terminals.

Picture 4a. Screw and well tighten the side of the terminals to the main body. In order for strong tightening to be achieved, connect the plug to its corresponding male or female pair and repeat the previous procedure.

Picture 4b. Cable's gland has to be strongly tightened.

Cables and power connectors description.

Luminaire is delivered with or without power connectors. When connectors are not available the cables will have color coding as mentioned in the parentheses. When connectors are available each pole has a numeric description. In the brackets below you can find the number as it is marked on each cable.

Monochromatic Models.

Male 2p. Female 2p.

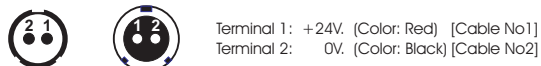

Tunable white (Warm-Cool) Models.

Male 3p. Female 3p.

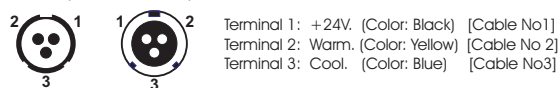

Tunable white (Warm-Neutral-Cool) Models.

Male 4p. Female 4p.

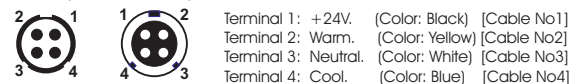

RGB Models.

Male 4p. Female 4p.

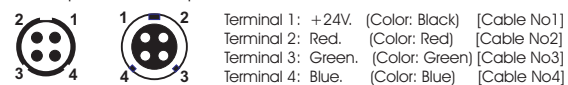

RGBW Models.

Male 5p. Female 5p.

